



十速

# T-Link-EV2268

*User Manual*

*Rev 0.90*

**tenx** reserves the right to change or discontinue the manual and online documentation to this product herein to improve reliability, function or design without further notice. **tenx** does not assume any liability arising out of the application or use of any product or circuit described herein; neither does it convey any license under its patent rights nor the rights of others. **tenx** products are not designed, intended, or authorized for use in life support appliances, devices, or systems. If Buyer purchases or uses tenx products for any such unintended or unauthorized application, Buyer shall indemnify and hold tenx and its officers, employees, subsidiaries, affiliates and distributors harmless against all claims, cost, damages, and expenses, and reasonable attorney fees arising out of, directly or indirectly, any claim of personal injury or death associated with such unintended or unauthorized use even if such claim alleges that tenx was negligent regarding the design or manufacture of the part.

---

## AMENDMENT HISTORY

<b>Version</b>	<b>Date</b>	<b>Description</b>
V0.90	Nov, 2016	New release.

# CONTENTS

<b>AMENDMENT HISTORY .....</b>	<b>2</b>
<b>1. Outline.....</b>	<b>4</b>
<b>2. Introduction.....</b>	<b>4</b>
<b>3. T-Link-EV2268 Hardware Description .....</b>	<b>5</b>
<b>4. How to start using T-Link-EV2268 simulation .....</b>	<b>7</b>
<b>5. How to use four wires to program or simulate by T-Link Board.....</b>	<b>18</b>
<b>6. How to update tenx IDE &amp; T-Link F/W .....</b>	<b>19</b>
<b>7. How to use Touch Key Application .....</b>	<b>21</b>
<b>8. How to use LCD Application .....</b>	<b>25</b>
<b>9. Q &amp; A .....</b>	<b>27</b>

## 1. Outline

Tenx (tenx technology) F51 & L51 Series single-chip is compatible with 8051, the user can use Keil uVision series of software as a development environment, this article will introduce the software and hardware configuration in Keil C.

## 2. Introduction

Figure 2-1 is T-Link-EV2268 development board, the left portion is called EV2268 Board and the right portion is called T-Link ICE Board to connect PC to use, the user can simulate TM52F2268 through this development board, please refer to TM52F2268 datasheet in detail.

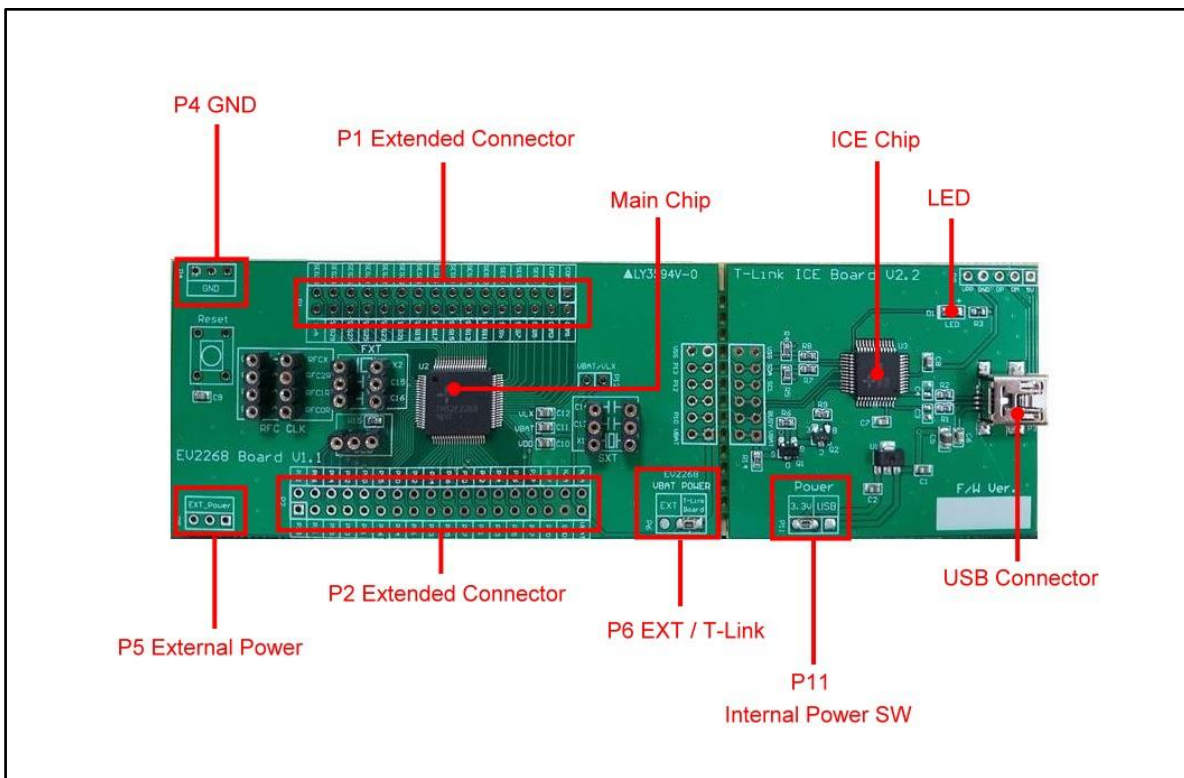
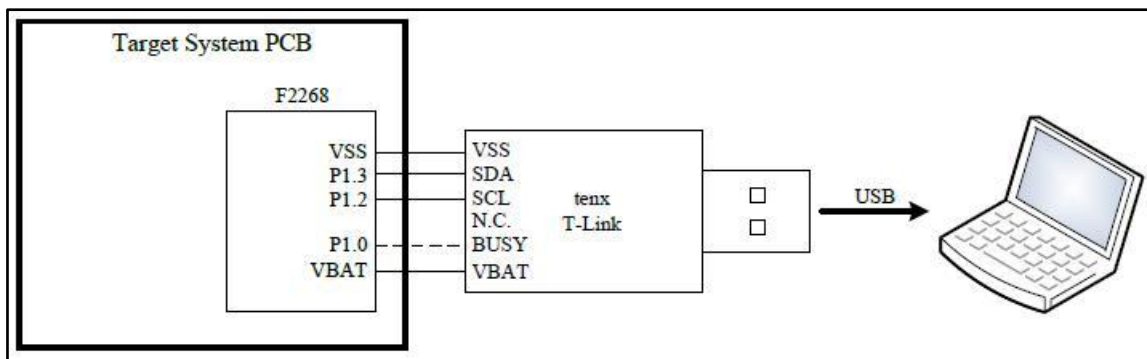

Figure 2-1. T-Link-EV2268 Board



### **3. T-Link-EV2268 Hardware Description**

#### **3.1 Power Setting**

- P5: Connect to external power (EV2268 Board)
- P6: Internal or external power source selection (EV2268 Board)
- P11: Internal power selection (T-Link Board)

<b>MCU Power</b>	<b>P11</b>	<b>P5</b>	<b>P6</b>
External Power	USB or 3.3V	EXT_Power	EXT
Internal Power	USB or 3.3V	X	T-Link Board

#### **3.2 USB Connector**

- P3: Mini USB connector to PC (T-Link Board)

#### **3.3 Reset Button**

- Reset: Reset Button (EV2268 Board)

#### **3.4 External Power Connector**

- P5: External VBAT connector (EV2268 Board)
- P4: External GND connector (EV2268 Board)

#### **3.5 MCU External Frequency-RFC**

- R10: RFC0R (EV2268 Board)
- R11: RFC1R (EV2268 Board)
- R12: RFC2R (EV2268 Board)
- C17: RFCX (EV2268 Board)

#### **3.6 MCU External Frequency-FXT**

- X2: crystal FXT(1~8M) (EV2268 Board)
- C15: matching capacitor (EV2268 Board)
- C16: matching capacitor (EV2268 Board)

#### **3.7 MCU External Frequency-SXT**

- X1: crystal SXT(32.768K) (EV2268 Board)
- C13: matching capacitor (EV2268 Board)
- C14: matching capacitor (EV2268 Board)

### 3.8 PIN Assignment & Description

EV2268 Board contains TM52F2268 main chip, packaged is LQFP 80-pin as shown below table for the pin assignment instructions.

Pin Number	Pin Name	Pin Number	Pin Name
1	N.A	41	N.A
2	N.A	42	N.A
3	SEG29	43	SX2/P2.0
4	SEG30	44	SX1/P0.7
5	SEG31/P2.3	45	VSS
6	FX2/SEG32/P2.2	46	VDD
7	FX1/SEG33/P2.1	47	VBAT
8	SEG34/P0.6	48	VLX
9	SEG35/P0.5	49	COM0/SEG0
10	SEG36/P0.4	50	COM1/SEG1
11	RFC2R/SEG37/P0.3	51	COM2/SEG2
12	RFC1R/SEG38/P0.2	52	COM3/SEG3
13	RFC0R/SEG39/P0.1	53	COM4/SEG4
14	RFCX/SEG40/P0.0	54	COM5/SEG5
15	MISO/SEG41/P2.6	55	COM6/SEG6
16	SCK/SEG42/P2.5	56	COM7/SEG7
17	MOSI/TK15/SEG43/P2.4	57	SEG8
18	RXD/TK14/SEG44/P3.0	58	SEG9
19	N.A	59	N.A
20	N.A	60	N.A
21	N.A	61	SEG10
22	N.A	62	SEG11
23	TXD/TK13/SEG45/P3.1	63	SEG12
24	INT0/TK12/SEG46/P3.2	64	SEG13
25	INT1/TK11/SEG47/P3.3	65	SEG14
26	T0/CLD/P3.4	66	SEG15
27	T1/PWMP/TK10/P3.5	67	SEG16
28	PWMN/TK9/P3.6	68	SEG17
29	TCO/TK8/P3.7	69	SEG18
30	T2/T2O/TK7/P1.0	70	SEG19
31	T2EX/AD1/TK6/P1.1	71	SEG20
32	AD2/TK5/P1.2	72	SEG21
33	TK4/P1.3	73	SEG22
34	TK3/P1.4	74	SEG23
35	TK2/P1.5	75	SEG24
36	AD6/TK1/P1.6	76	SEG25
37	TK0/P1.7	77	SEG26
38	VPP/RSTn/INT2/P2.7	78	SEG27
39	N.A	79	SEG28
40	N.A	80	N.A

## 4. How to start using T-Link-EV2268 simulation

First, Install the tenx TM52D11 IDE file to follow steps to complete the installation, the IDE & Keil C version must be installed in the same path, the default path is C:\Keil:

### 4.1 Select Keil C version, click “Next>”

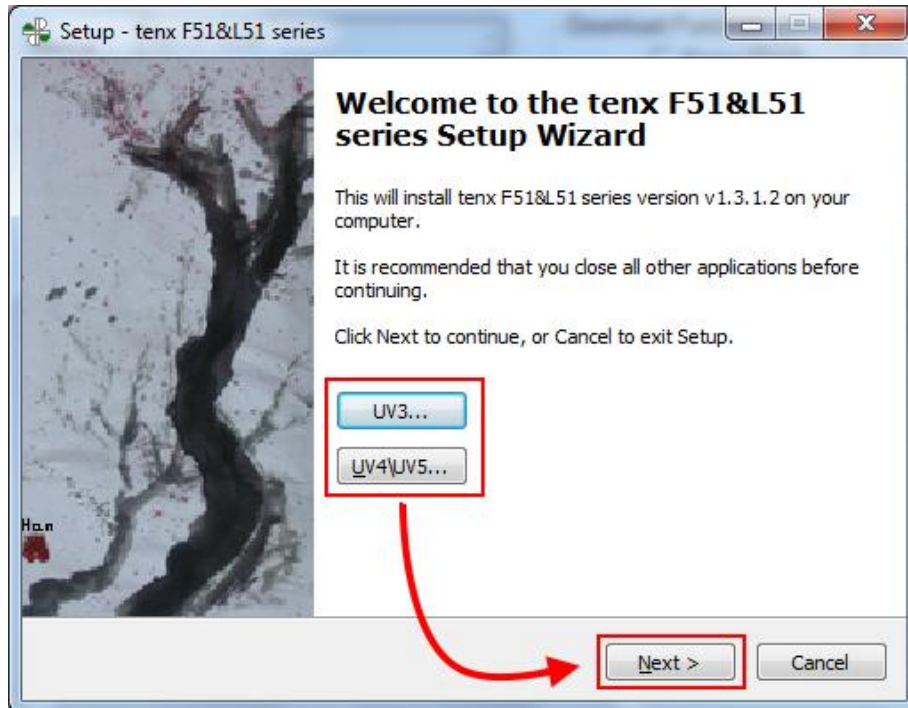

4.2 And then click “Next>”

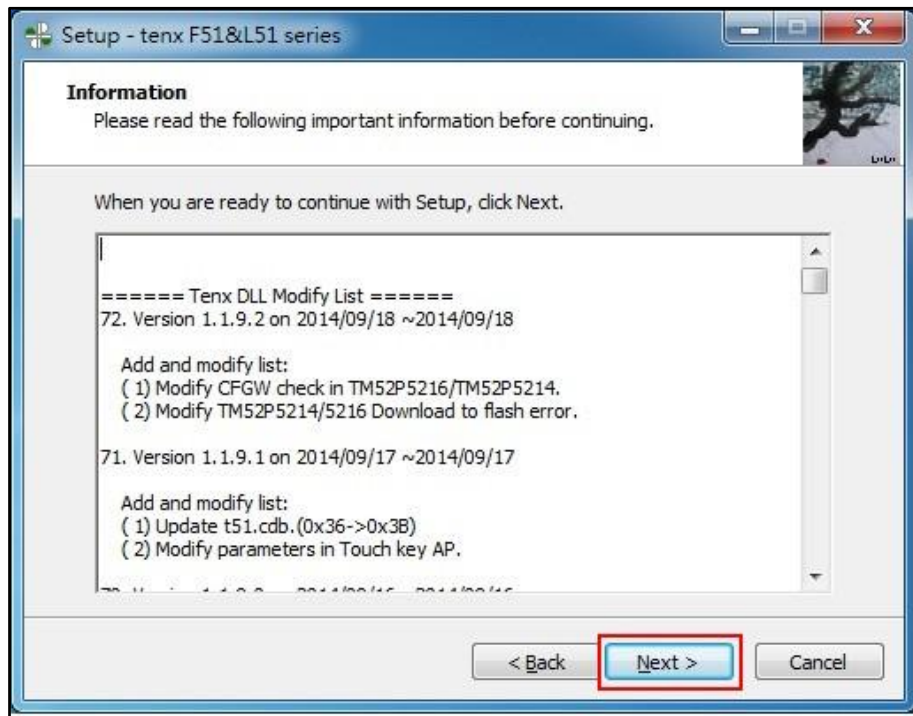

4.3 The default path is C: \Keil, click “Next>”

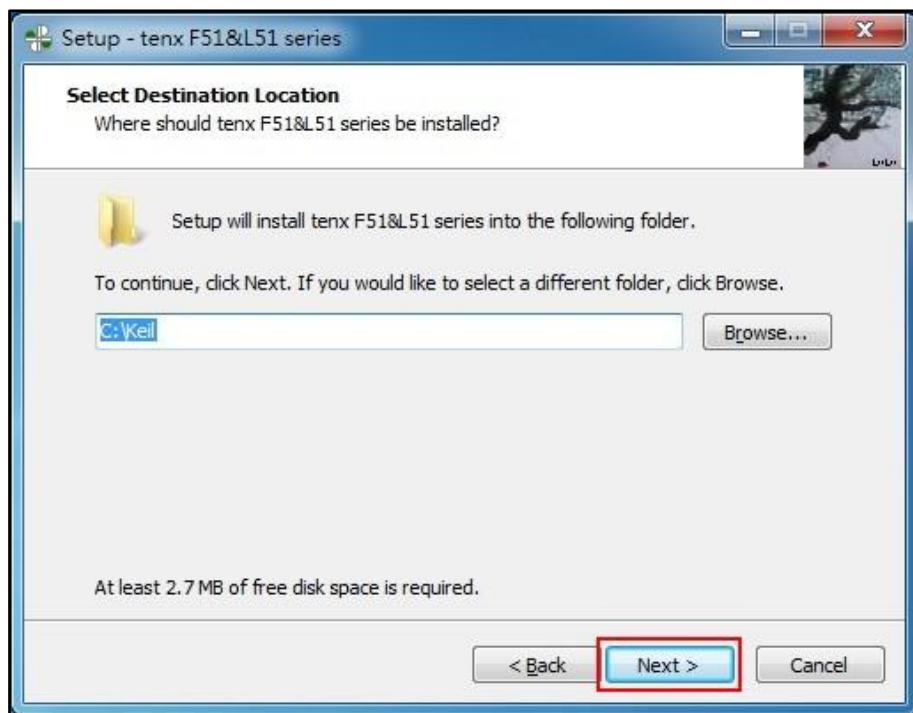



#### 4.4 Click “Install”

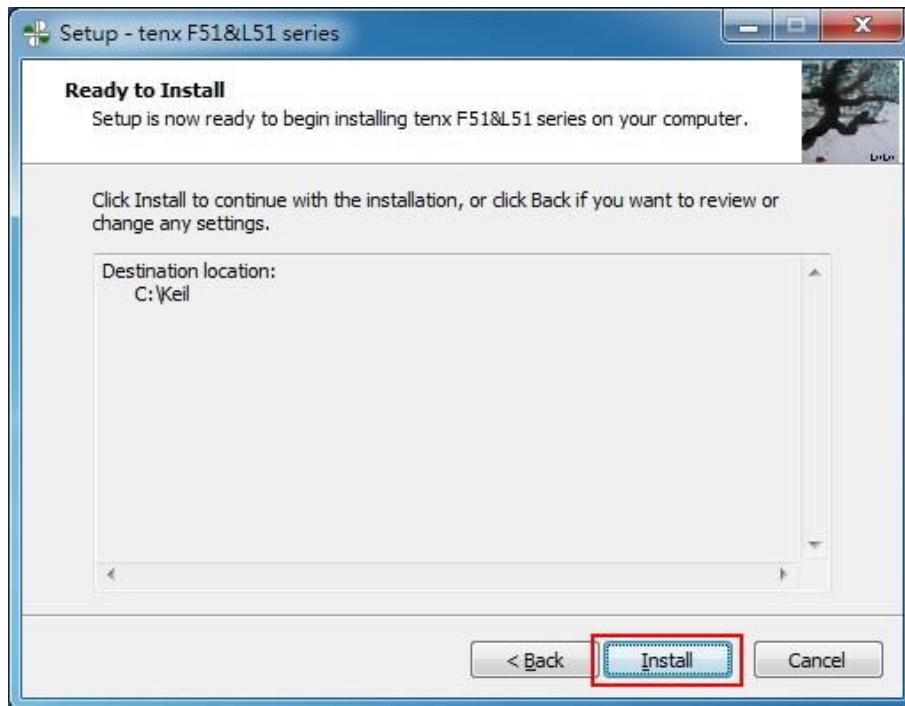

#### 4.5 Click “Finish” to complete the installation



#### 4.6 Connect T-Link-EV2268 Board of USB (mini type) connector to PC

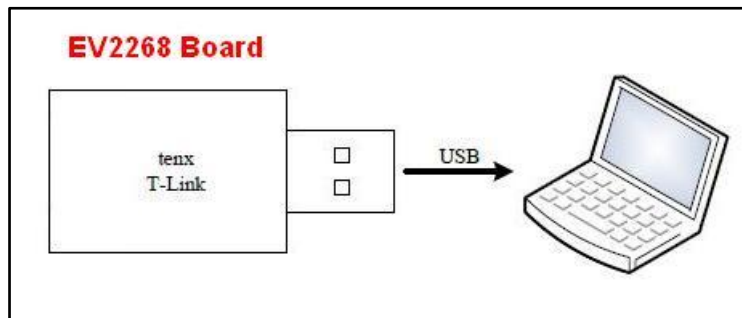

#### 4.7 Confirm Device Manger

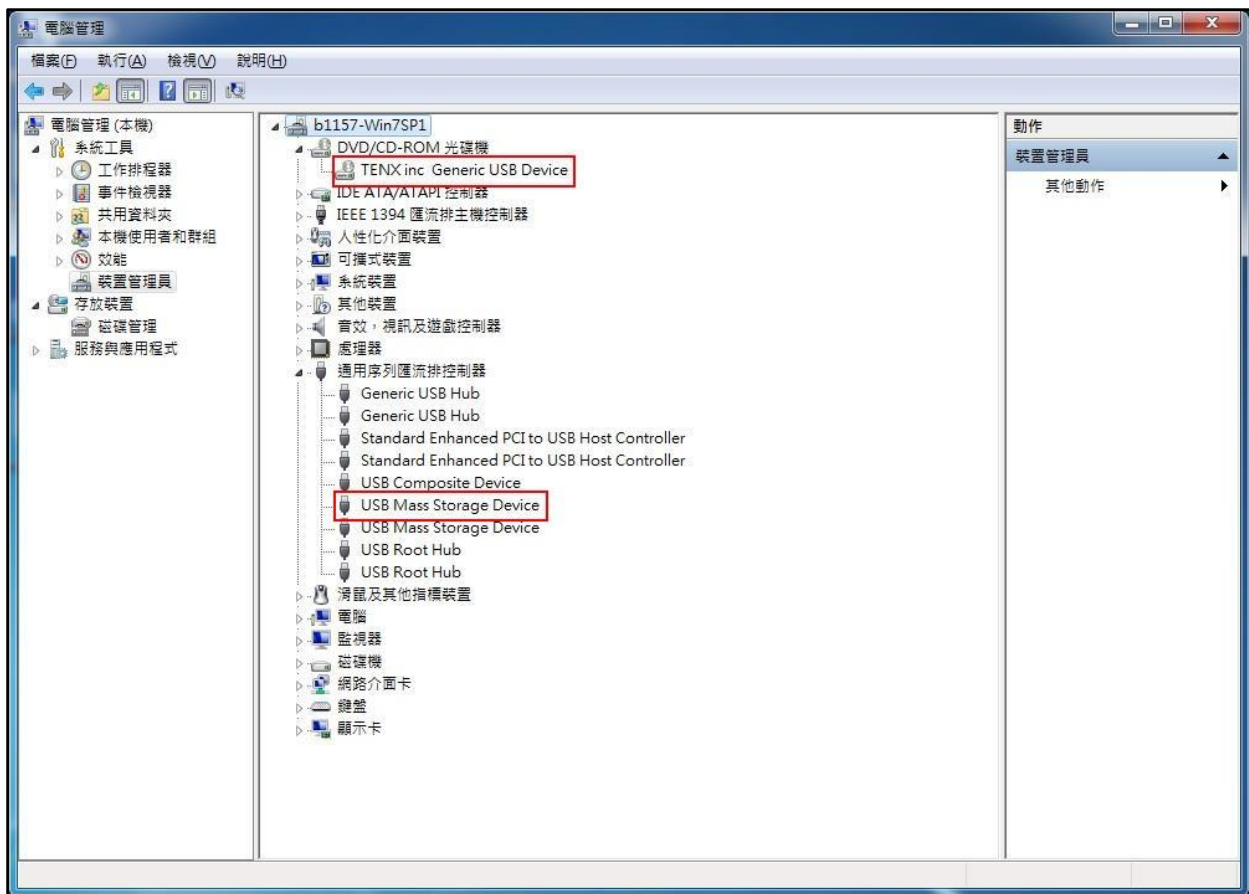

4.8 Open the KEIL C→Click the Project menu and select New Project window→Fill in the project name and click Save Project→Copy tenx 8051 Startup Code or not ?

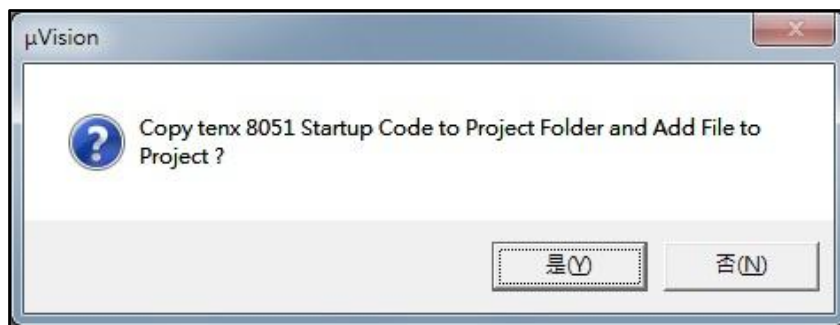
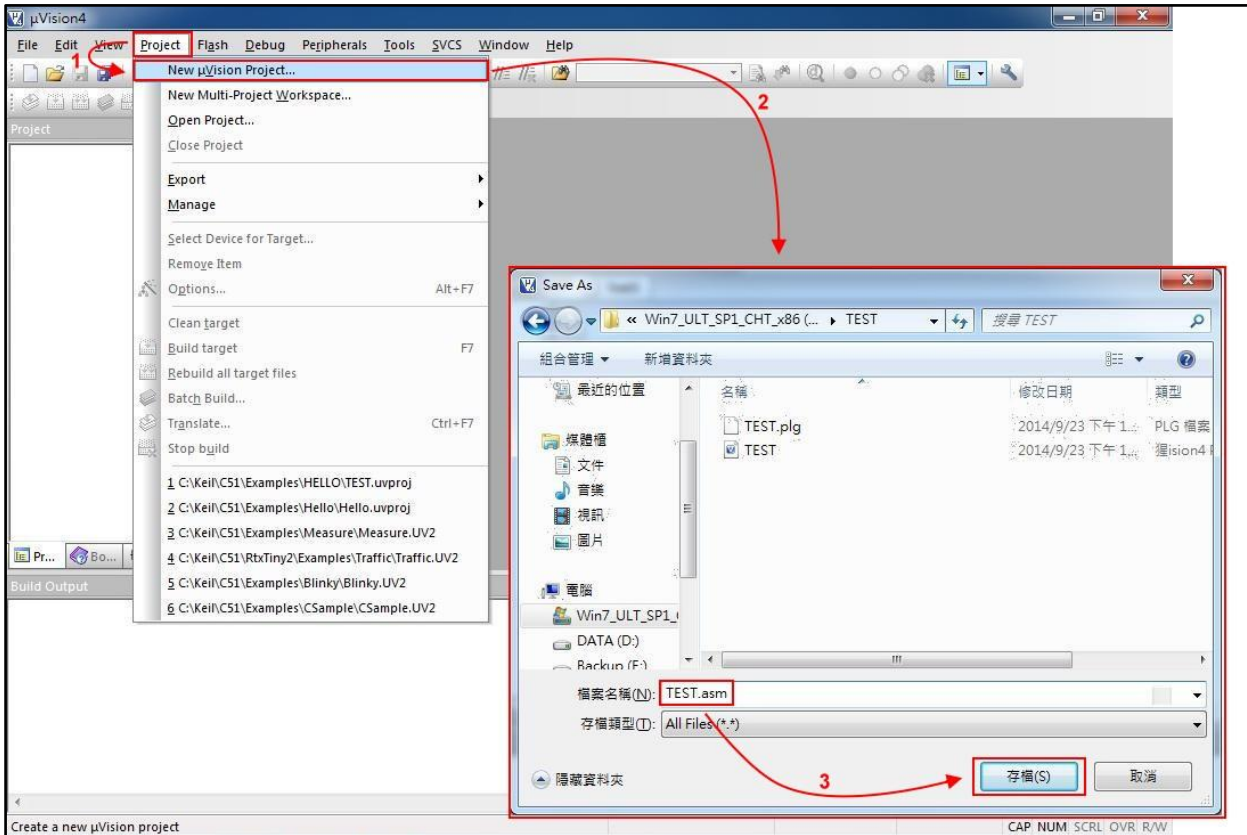

4.9 CPU Data Base selection dialog box will be show up→Select the tenx F8051 Devices and click on OK button→Select a CPU model (for EV Board model), refer to Note (1) and the right window shows some of the parameters of this single chip model.

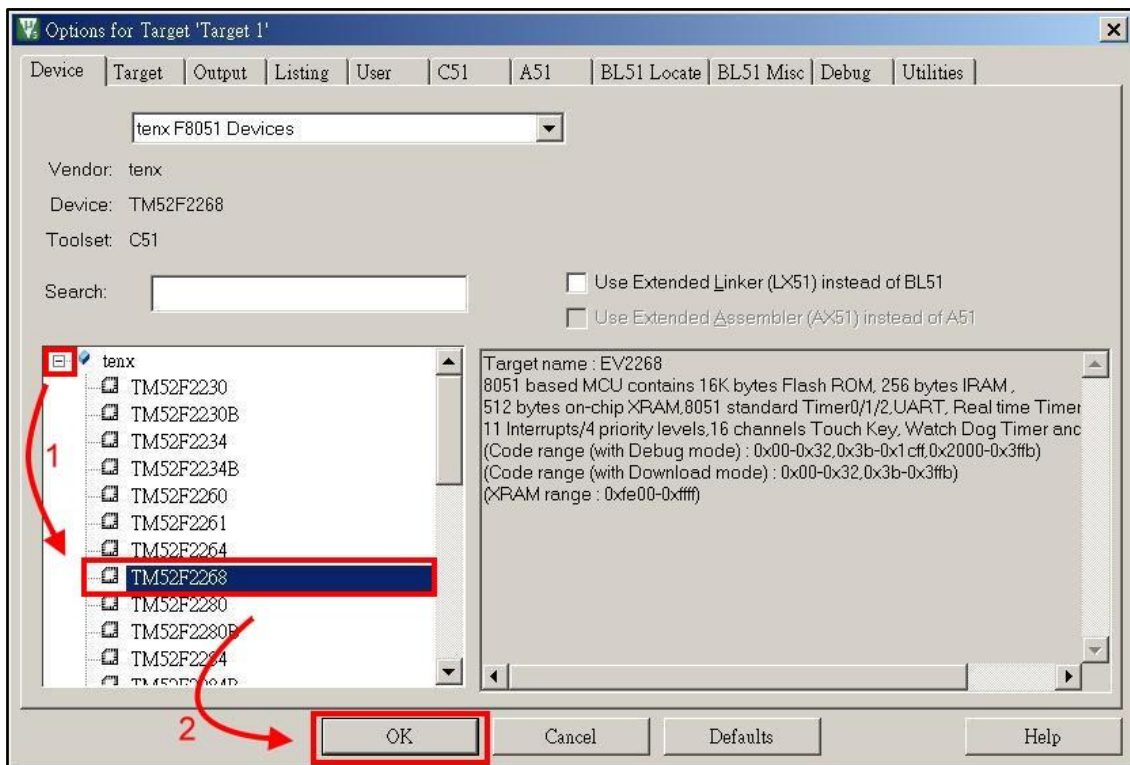
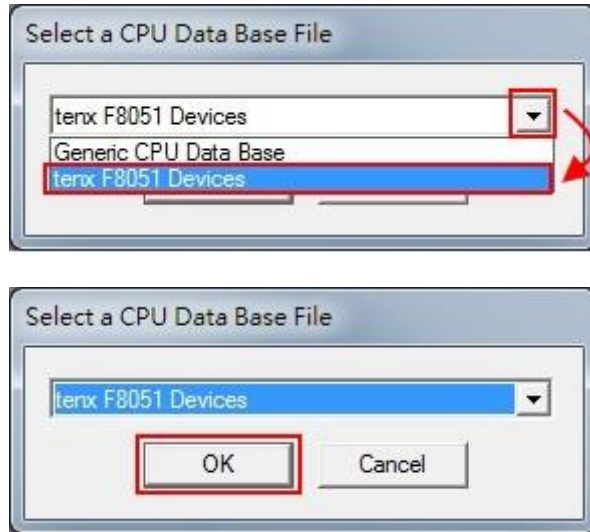

**Note (1): TM52F2268 (For EV Board model)**

Chip Model	EV Board Model
TM52F2268	EV2268

4.10 Option for Target dialog box settings: Click the “Option for Target” button in the main menu, the project file is created must also be relevant to the project file settings as shown below.

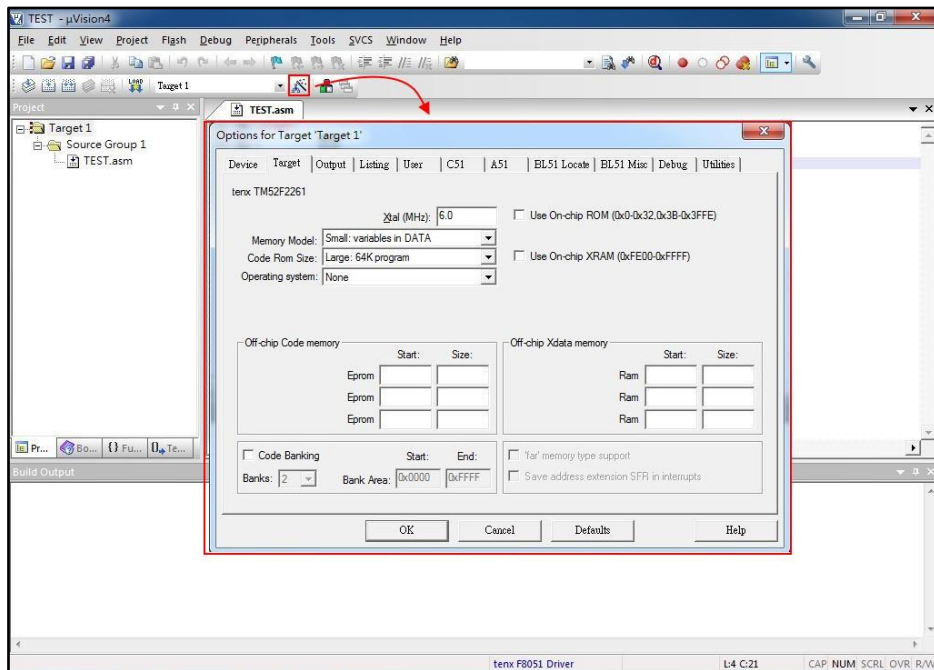

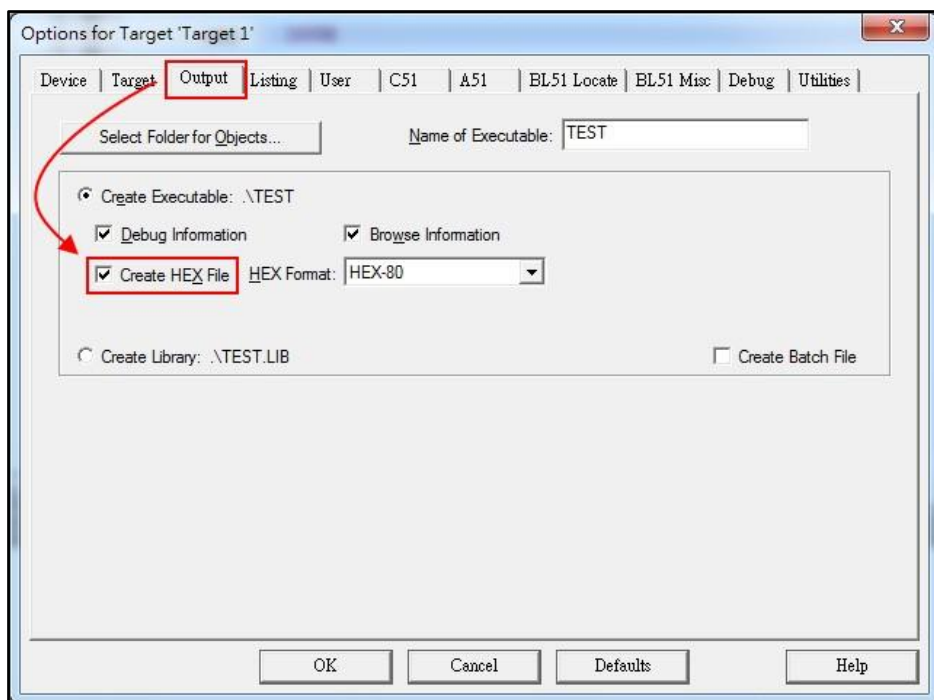

4.11 Output dialog box settings: To confirm “Create HEX File” option is checked, as shown below.

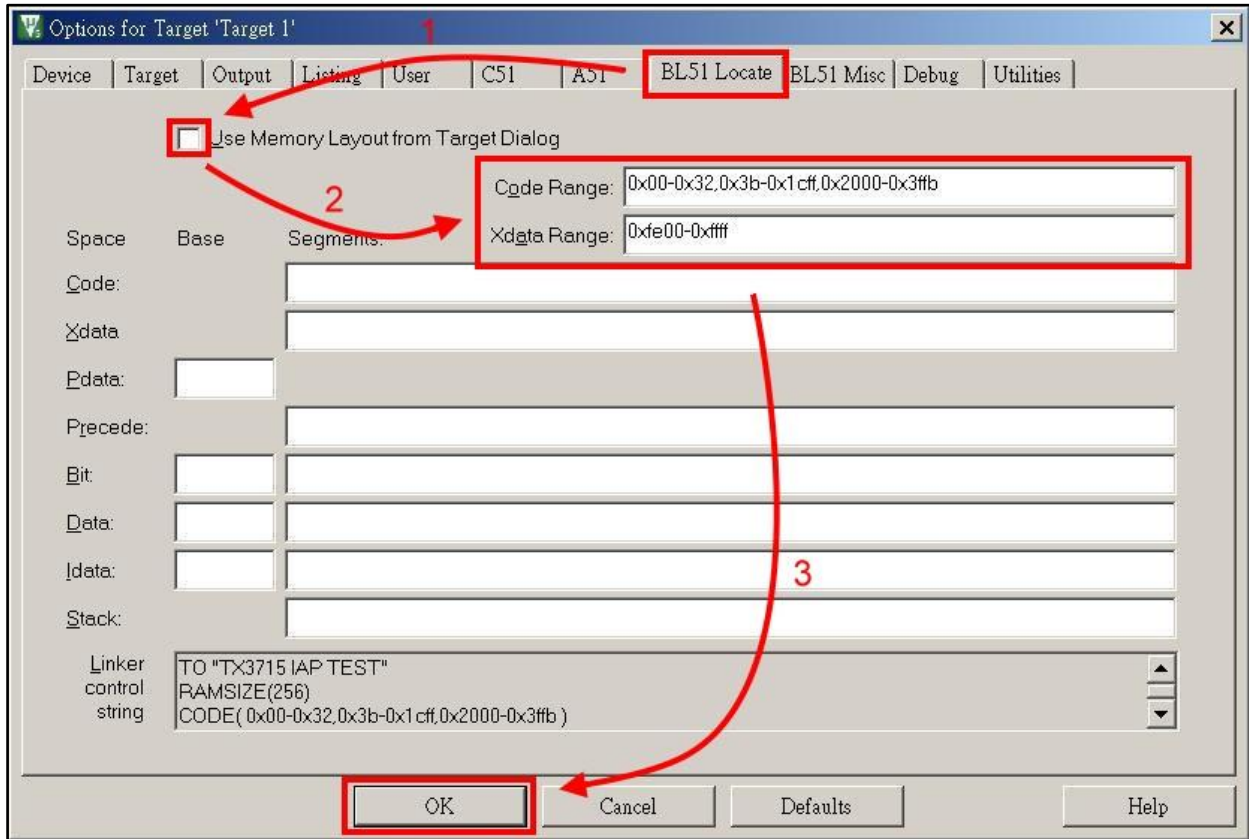

4.12 BL51 Locate dialog box settings: Unchecked “Use Memory Layout from Target Dialog” in BL51 Locate option and fill in Code & Xdata Range (Note: The chip code available range has divided into download mode and debug mode , please refer to Note (2) )



Note (2): TM52F2268 (EV2268) Code Range area (Program ROM)

Chip Model	Code Range		XRAM Range
	Download Mode 	Debug Mode 	
TM52F2268 (EV2268)	0x00-0x32, 0x3b-0x3ffb	0x00-0x32, 0x3b-0x1cff, 0x2000-0x3ffb	0xfe00-0xffff

4.13 Debug dialog box settings: Click on “Use:” option, and then select “tenx F8051 Driver” as shown below.

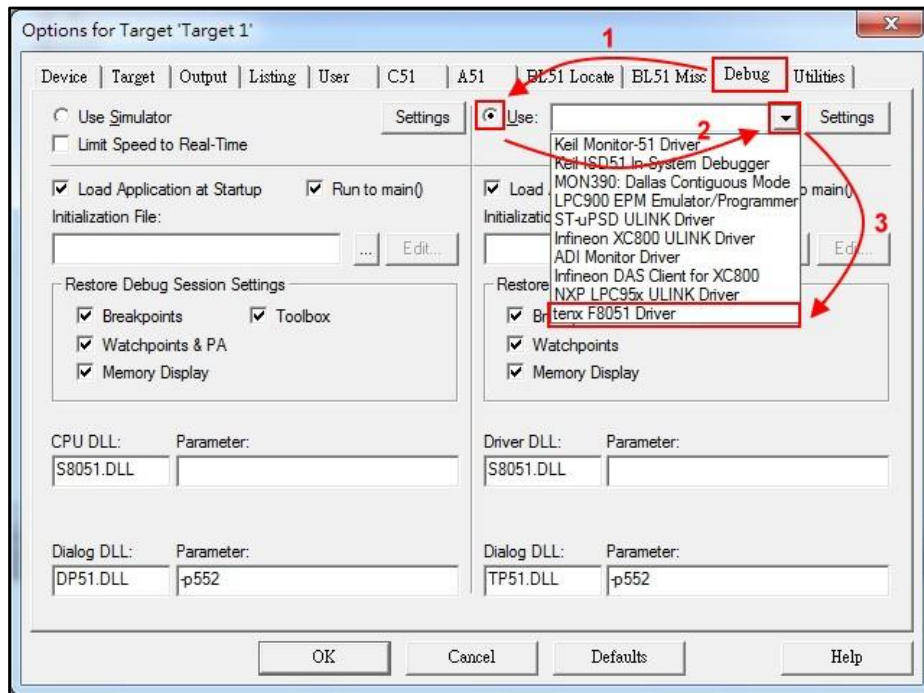

4.14 Utilities dialog box settings: Click on “Use Target Driver for Flash Programming” option and select “tenx F8051 Driver” as shown below.

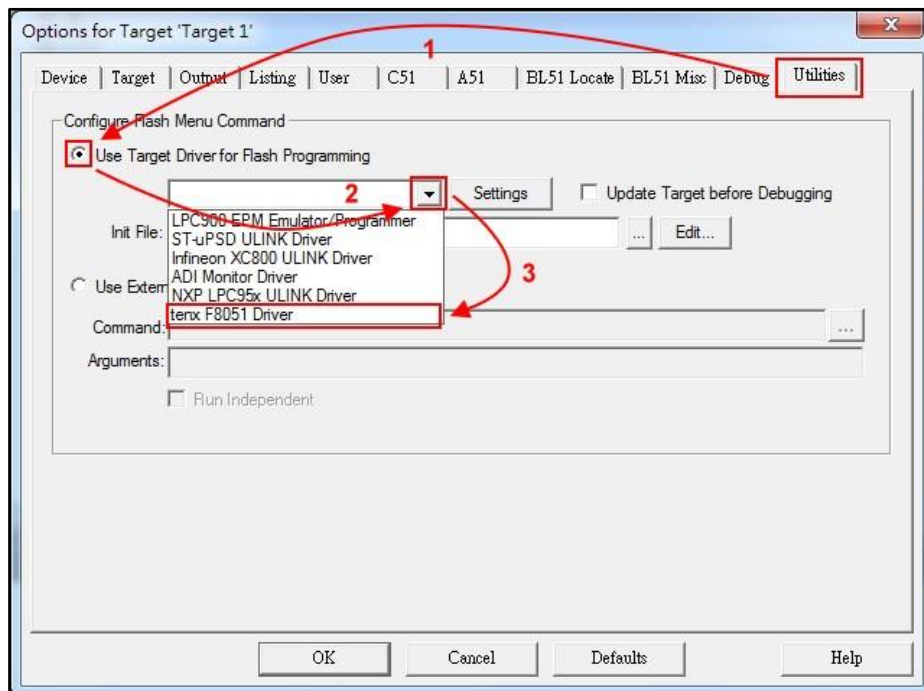

4.15 Click on “settings” button and the “Flash Download Setup” window will be show up, check the “Download Function” desired option as shown below.

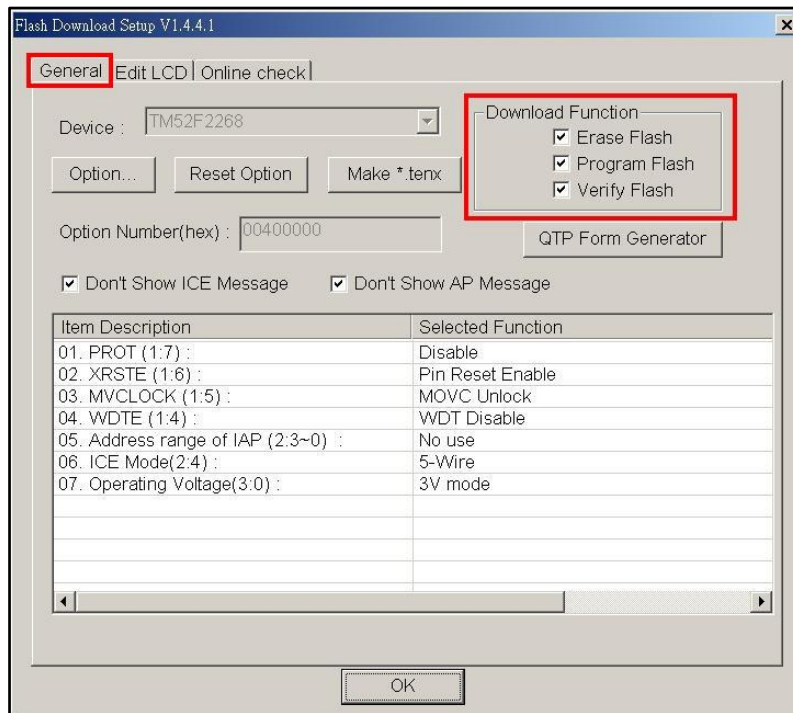

4.16 Click on “Option” button, and the “Smart Option” will be show up, about the option configuration, please refer to TM52F2268 datasheet.

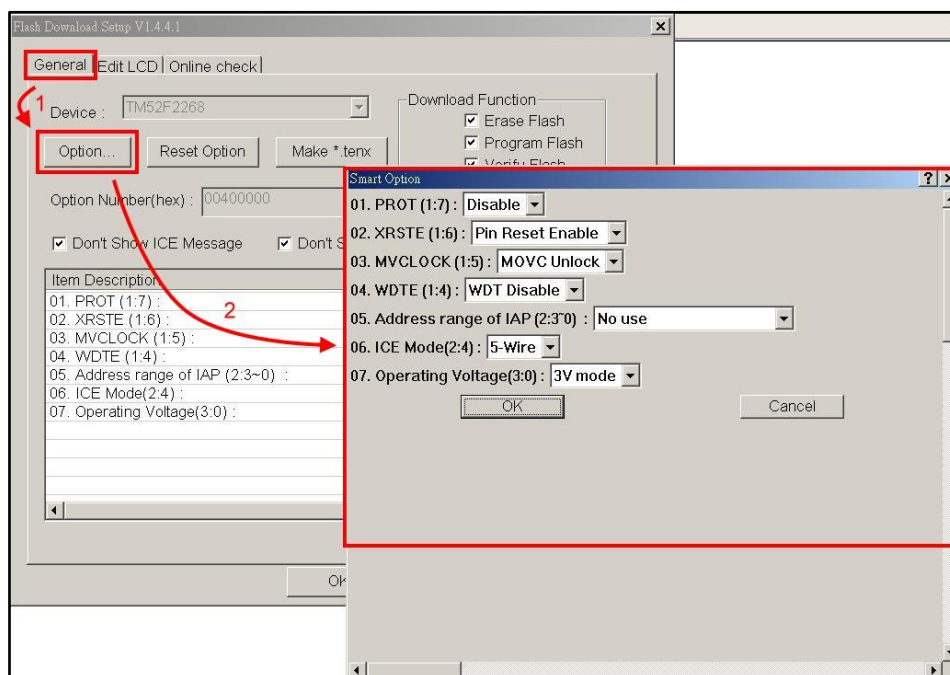



4.17 Click on “OK” to return to “Flash Download Setup” window, and then click on “OK” to return to “Utilities” window, this all new project configuration is complete and click on “OK” to exit the “Option for Target” window, the user can start programming now. (Note: To change chip model ,user needs to confirm “Code Range” and “Option” settings, the “Open Project” will save the settings and the “New Project” will be default settings in the “Option” dialog box)

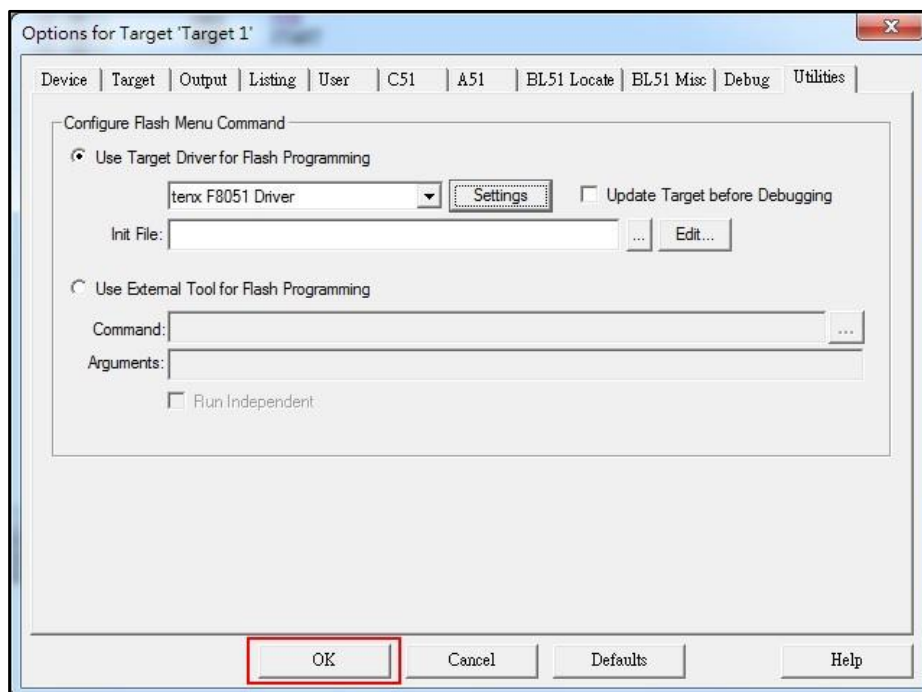
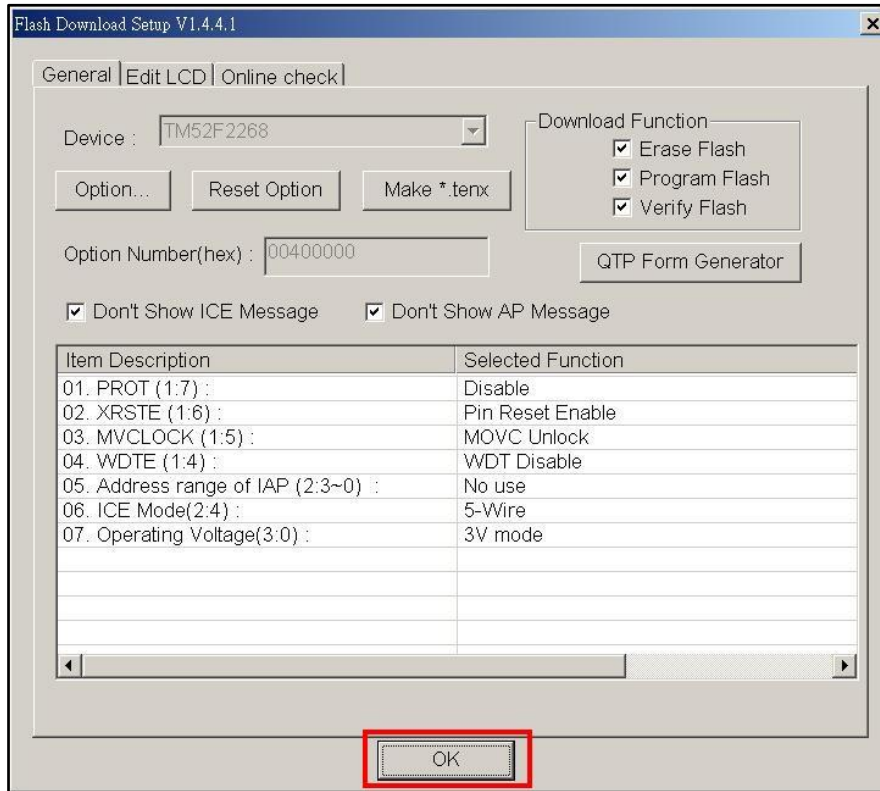

## 5. How to use four wires to program or simulate by T-Link Board

The T-Link ICE Board can use four wires (VBAT, VSS, P1.2, P1.3) or five wires (VBAT, VSS, P1.2, P1.3, P1.0) to program, user must to select 4-wire in “Utilities dialog box settings” .

5.1 Utilities dialog box settings: Click on “Option” button, and select 4-Wire, as shown below.

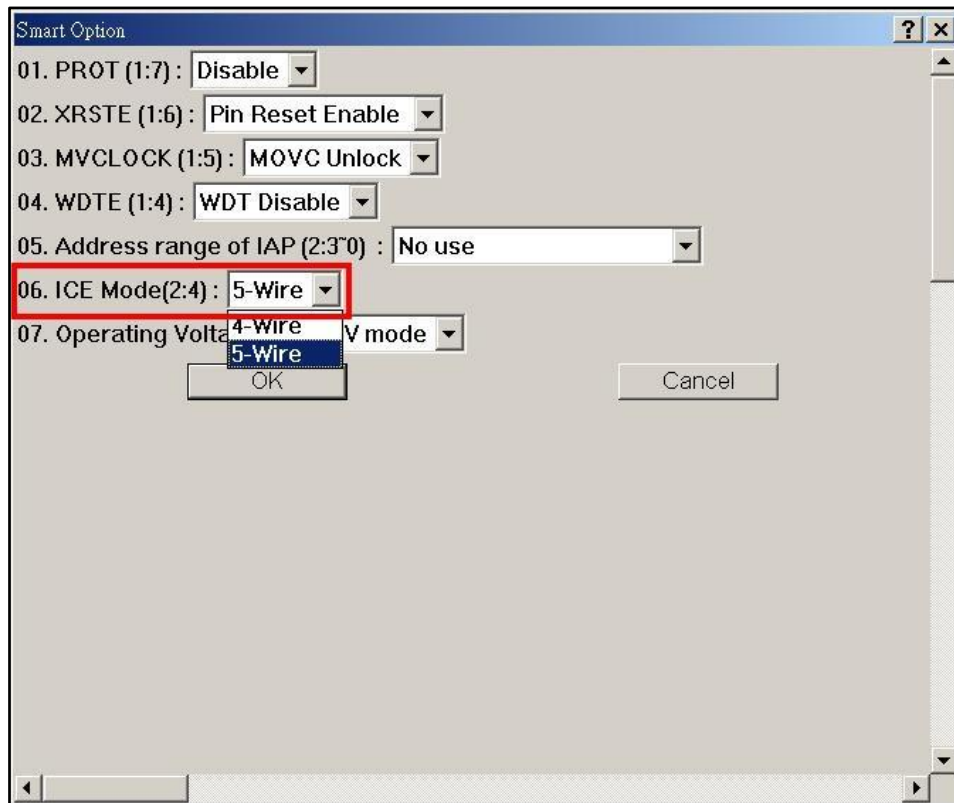

## 6. How to update tenx IDE & T-Link F/W

6.1 Update tenx IDE: Click on “Online check” button, and Update the TM52DI1 IDE in Utilities dialog box, as shown below.

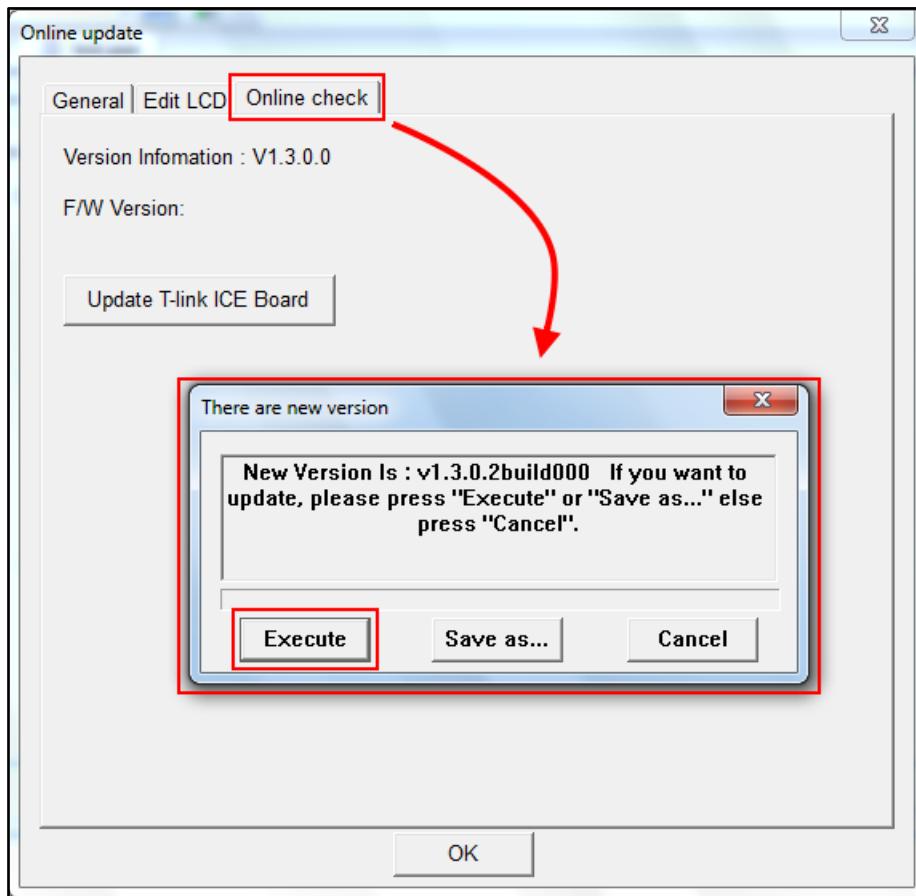

6.2 Update T-Link F/W: Connect TUT52 Writer to USB and T-Link Board, as shown below.

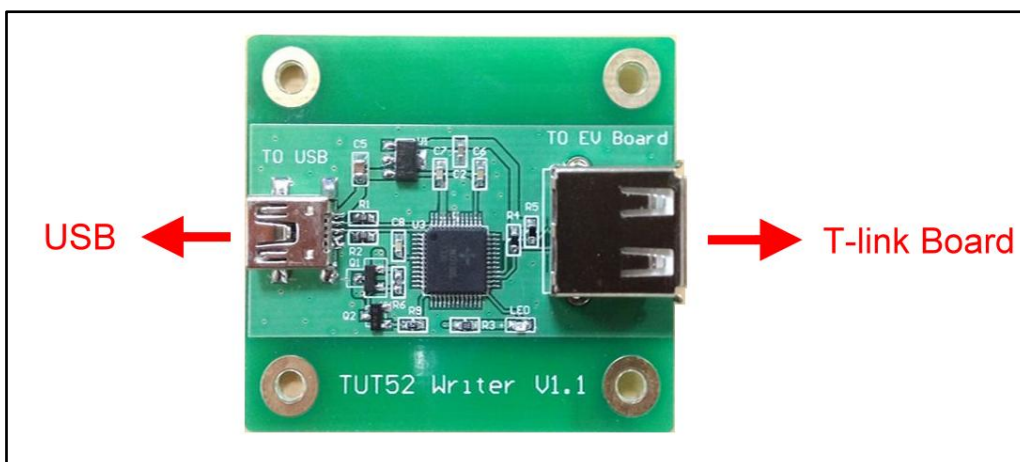

6.3 Click on “Update T-Link ICE Board” button to update T-Link Board F/W, as shown below.

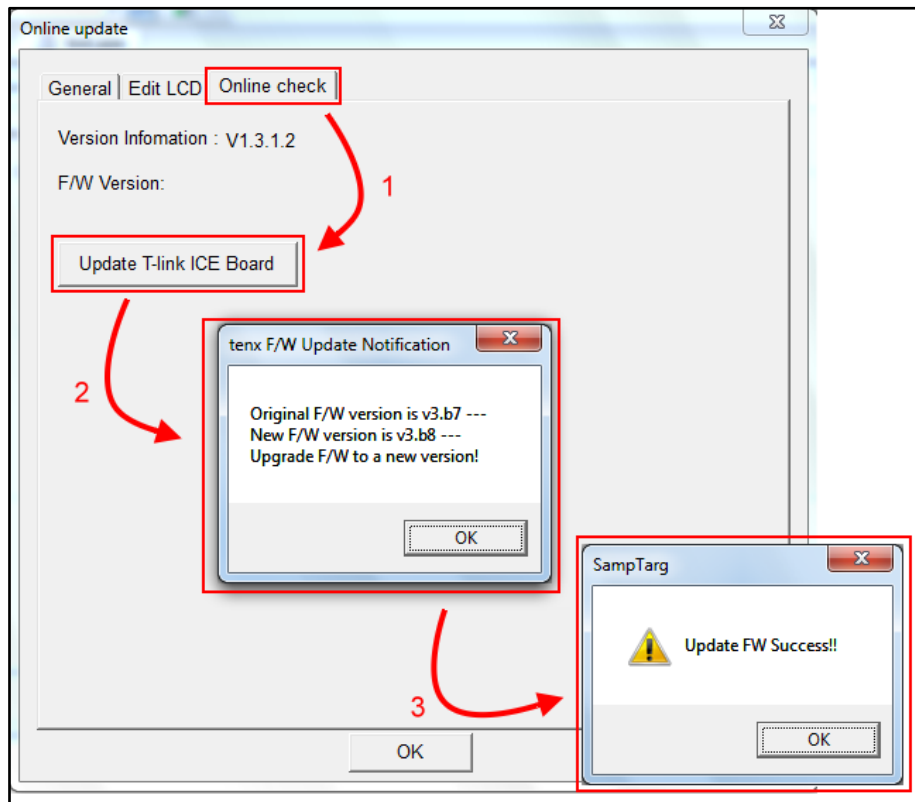

## 7. How to use Touch Key Application

The Touch Key Application work in Debug Mode, user can use application to view the results of TK Data. The TK Data must be stored in XRAM and IRAM range, as shown below.

### 7.1 Click on “Debug” into Debug mode.

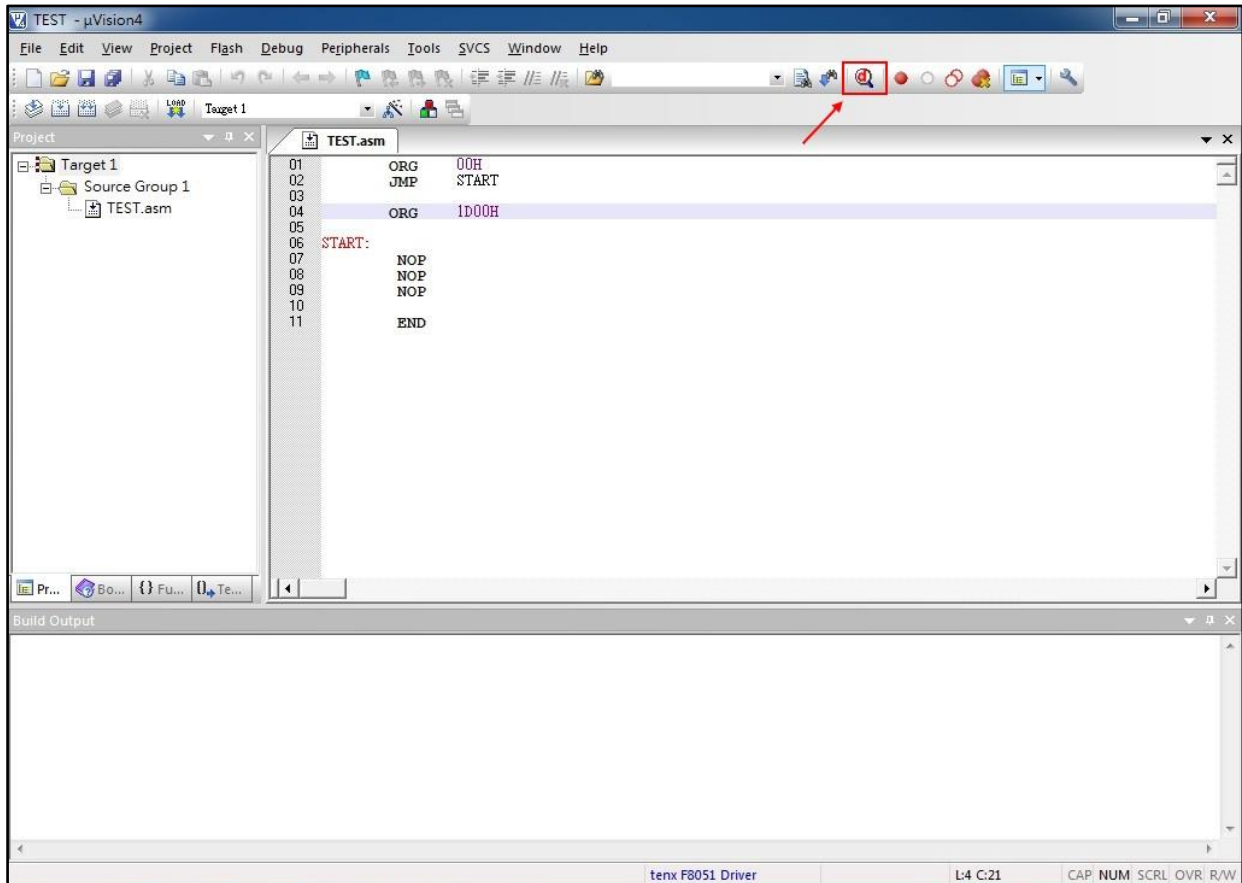

7.2 Click the Debug menu and select “Display Touch Key AP and Run”.

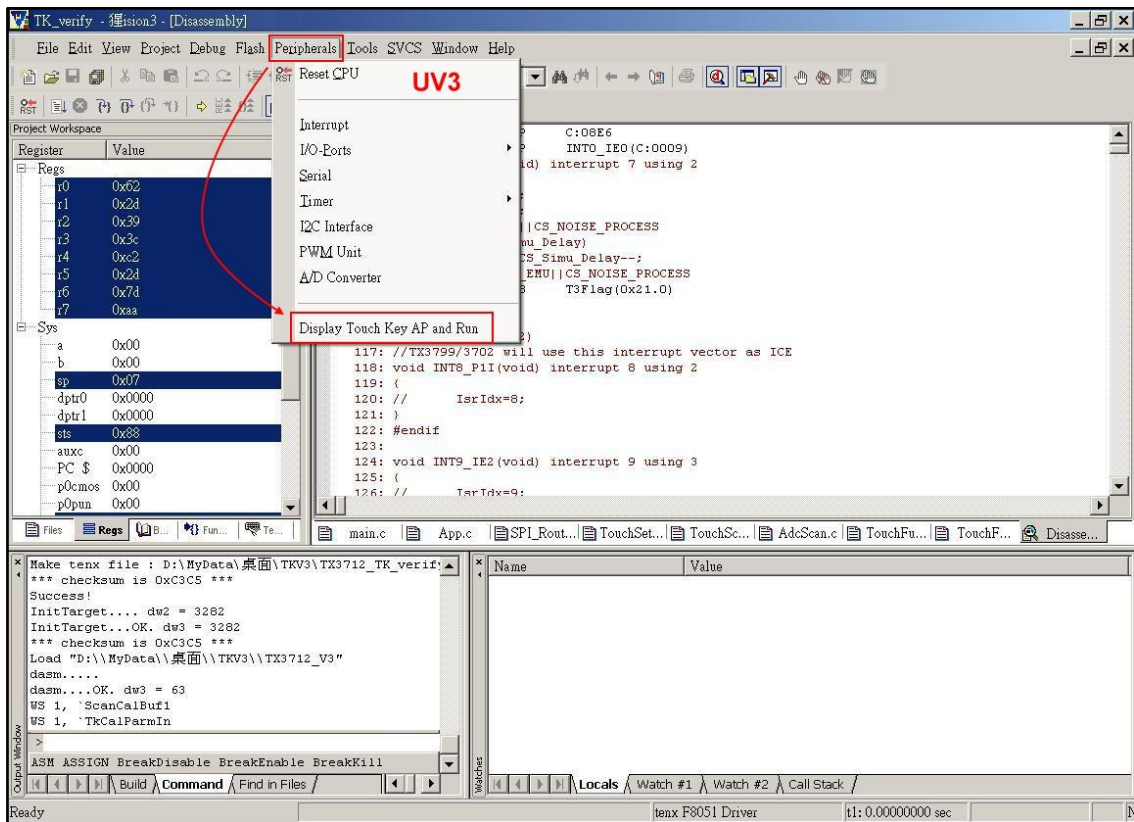
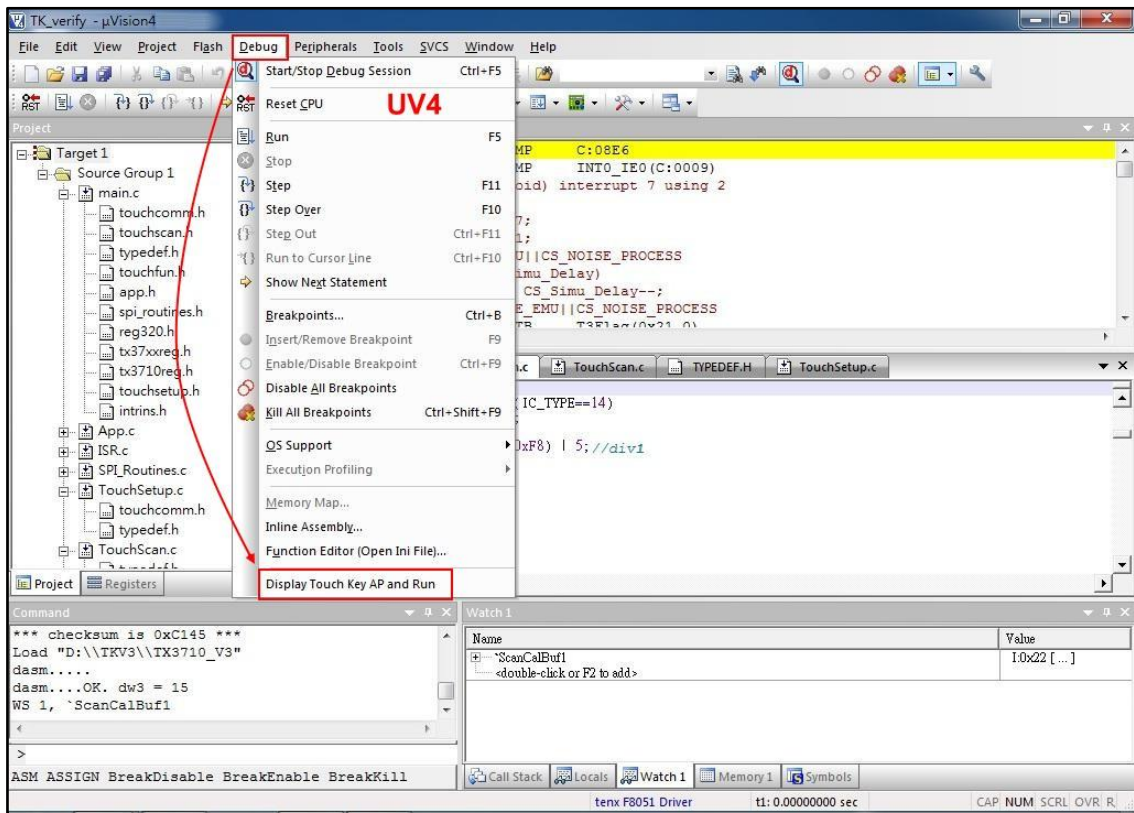

### 7.3 Fill in TK Data, ex: TK name (address) and TK Bits and Total TK Channels.

Key-in symbol name for watch

TK Name or Address [Ex: "i:0x20"; "x:0xFF00"] :

TK data bits(8 or 11) :       Total TK channels : 0x

**Example1:**  
 TK data address = i:0x22  
 TK data bits = 8  
 Total TK channels = 0x3

**User must:**  
 Copy {TKDL[7:0]} of 1st TK into i:0x22  
 Copy {TKDL[7:0]} of 2nd TK into i:0x23  
 Copy {TKDL[7:0]} of 3rd TK into i:0x24

**Example2:**  
 TK data address = i:0x22  
 TK data bits = 11  
 Total TK channels = 0x2

**User must:**  
 Copy {5'b00000, TKOVF, TKDH} of 1st TK into i:0x22  
 Copy {TKDL[7:0]} of 1st TK into i:0x23  
 Copy {5'b00000, TKOVF, TKDH} of 2nd TK into i:0x24  
 Copy {TKDL[7:0]} of 2nd TK into i:0x25

**Note:**  
 1. Any touch key channel on ICE pins(maybe P1.2/P1.3) cannot be enabled.  
 2. Press OK, user code will auto freerun and ignore any break point.

Cancel
OK

### 7.4 Click on “OK” button, and the “TK AP” will be show up.

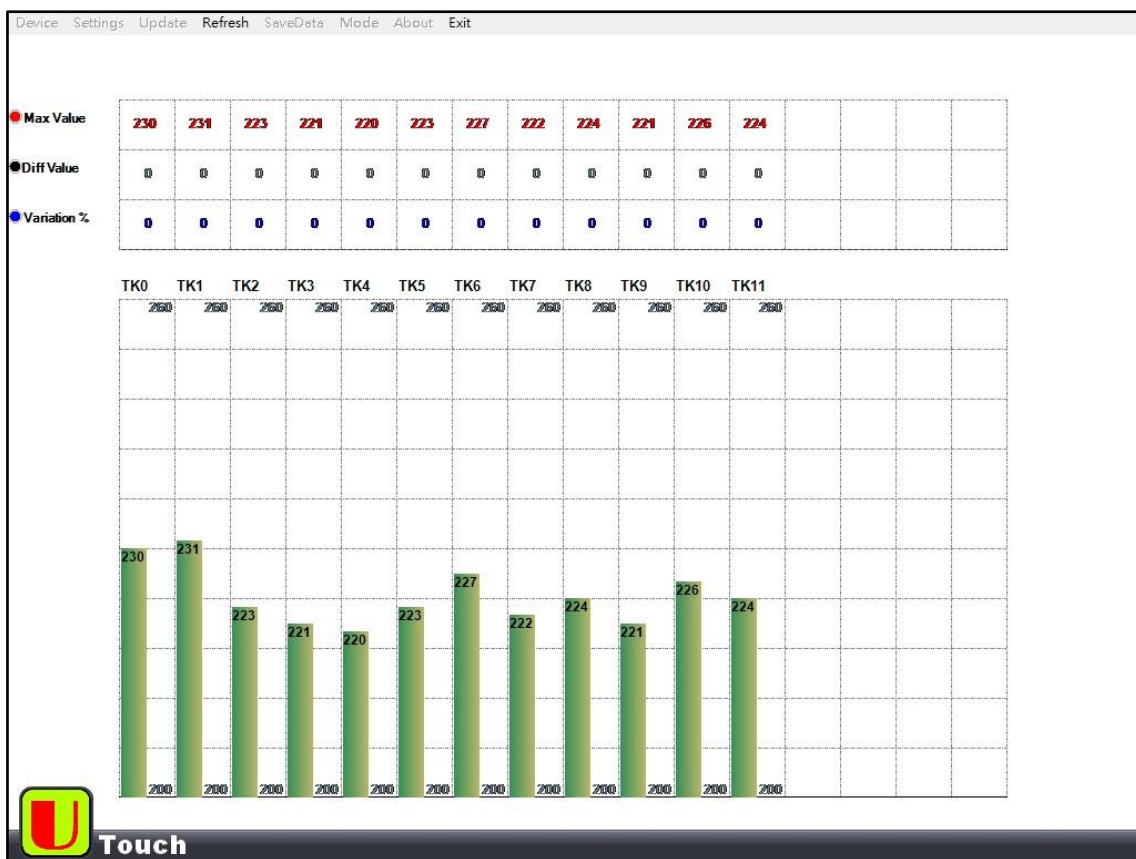

7.5 The TK AP Function, as shown below.

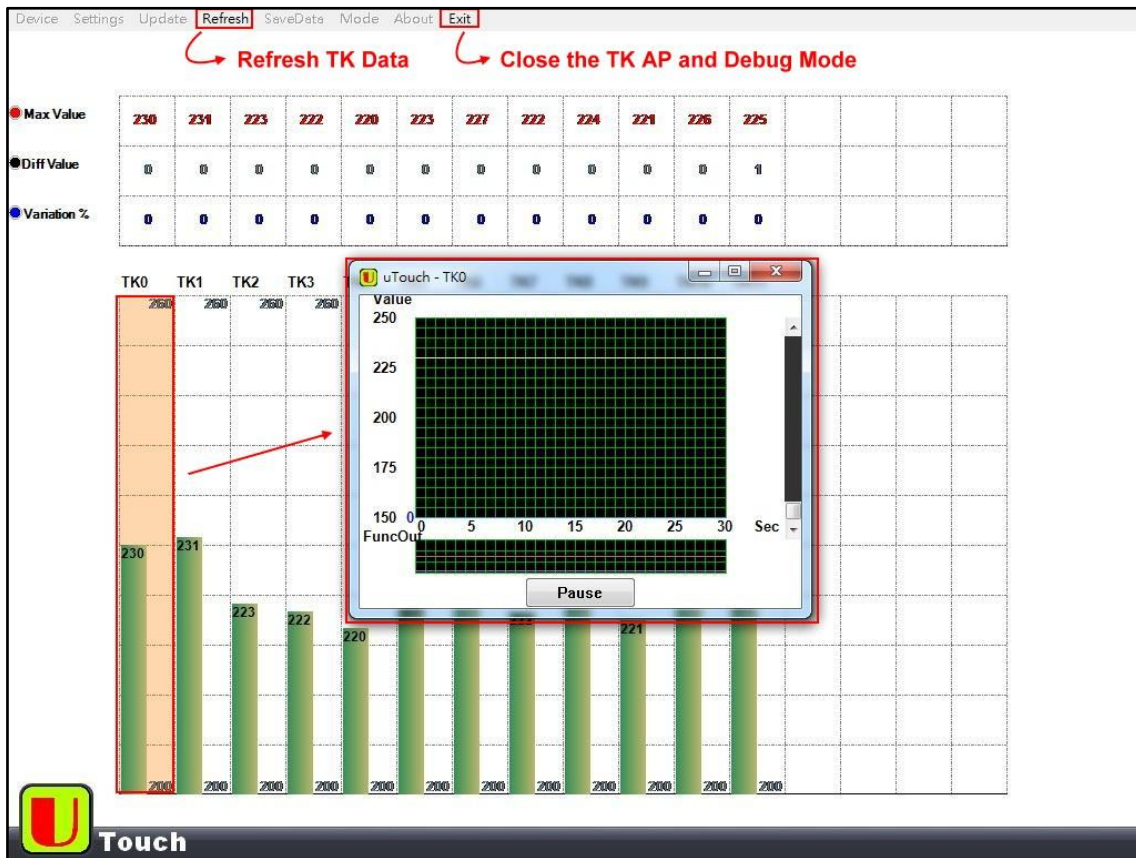



## 8. How to use LCD Application

The LCD Application can edit and work in Debug Mode, user can use application to simulator LCD Module, please refer to UM-EV22\_52XX\_LCDAP\_SV090 User Manual for more information.

8.1 Click on “Option for Target” button in the main menu, as shown below.

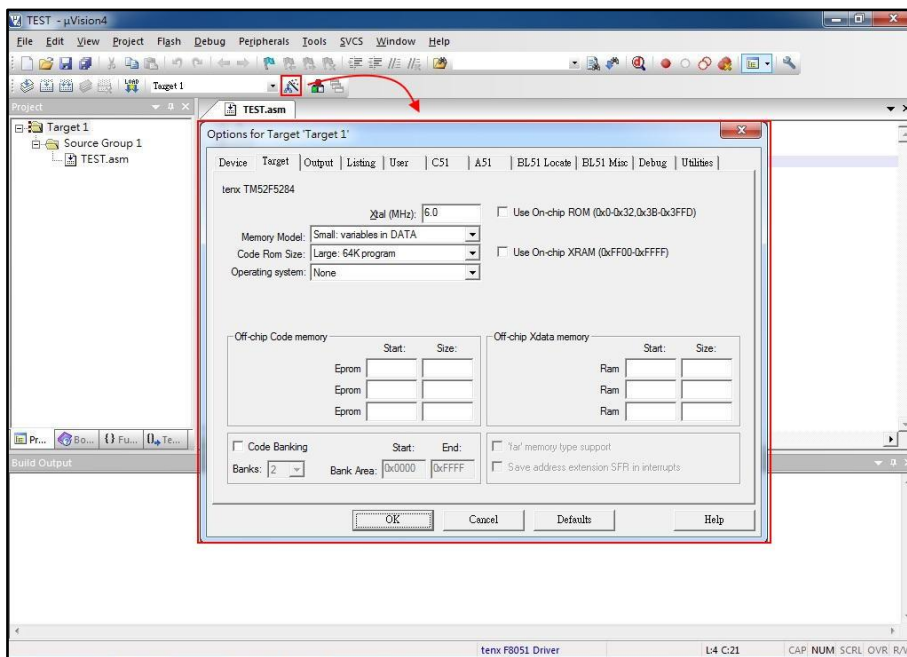

8.2 Click on “setting” Button in “Utilities” Digital box, as shown below.

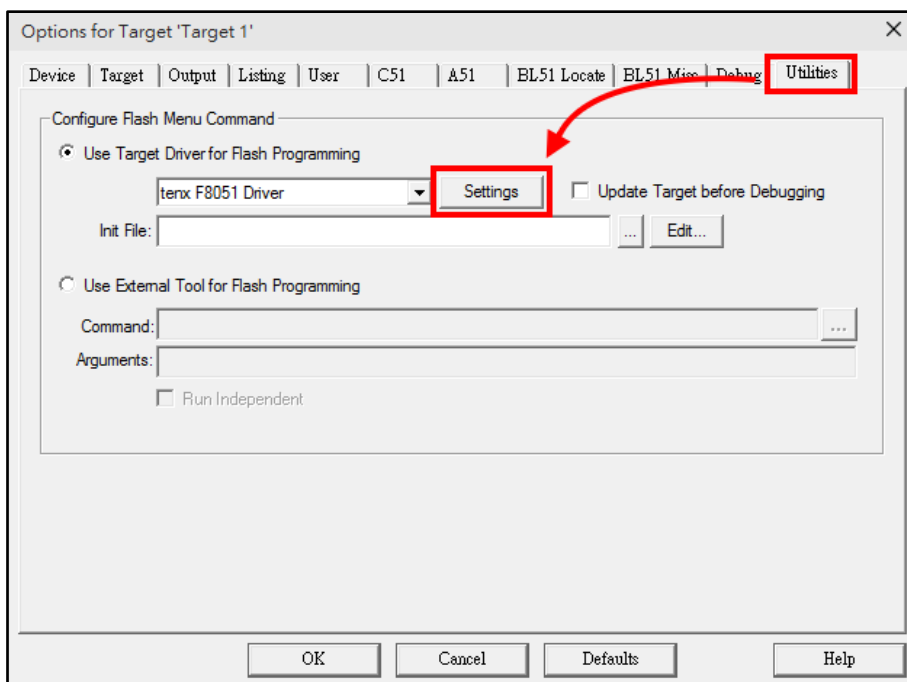

8.3 Click on “Edit LCD” Button and check “show LCD in debug” option, as shown below.

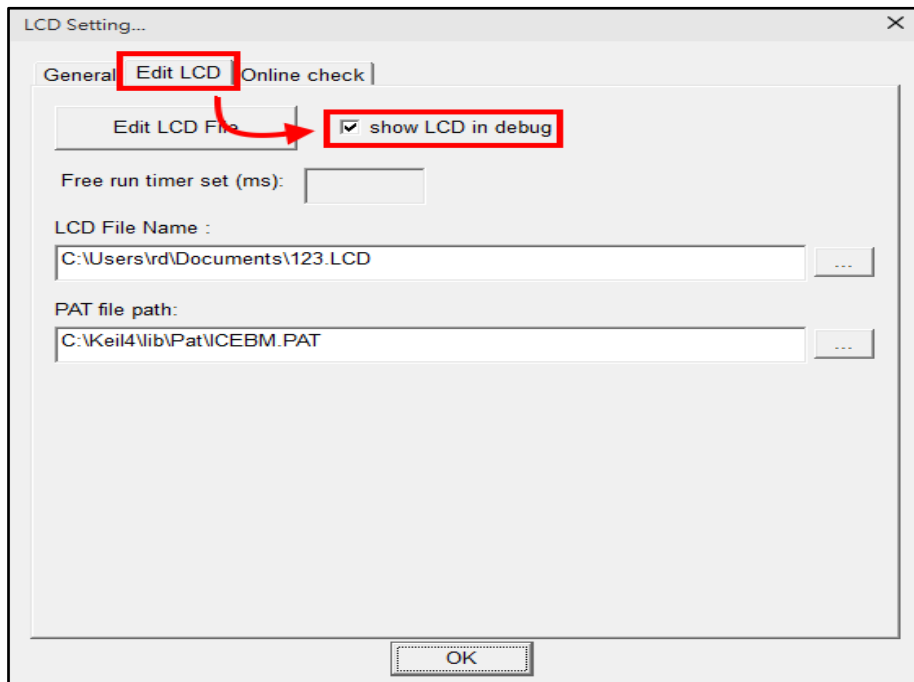

8.4 Click on “Debug” into Debug mode and the LCD Application will be show up, as shown below.

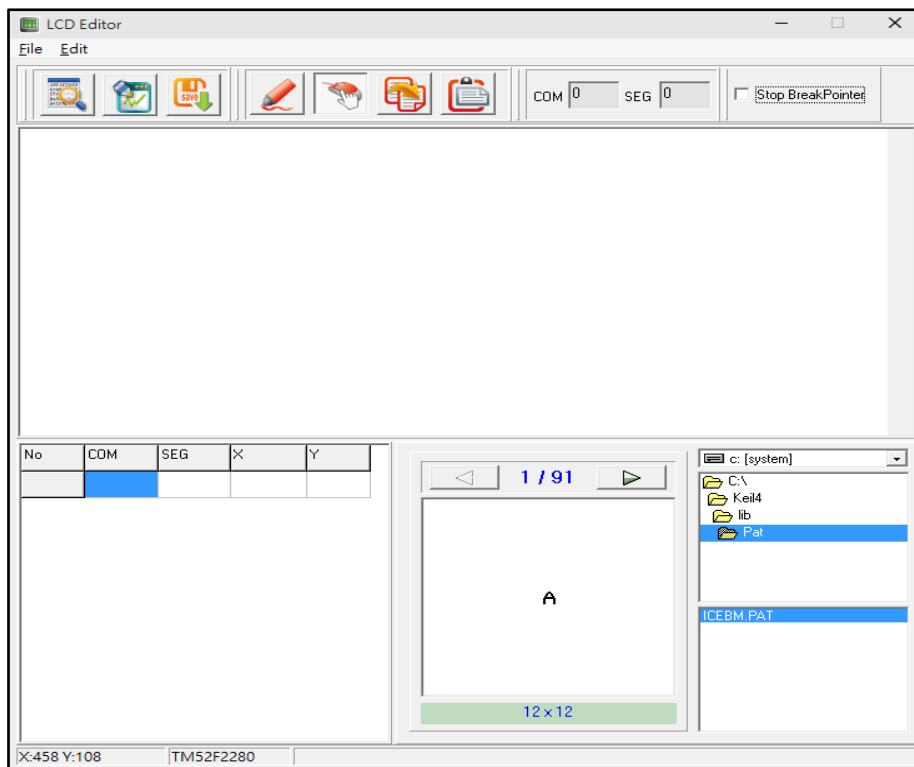

## 9. Q & A

### Q1: How to program a user file on TWR98 Writer ?

A1: The User must make “\*.tenx” file to program in “Utilities dialog box settings”, or enter “Download Mode” and “Debug Mode”, as shown below.

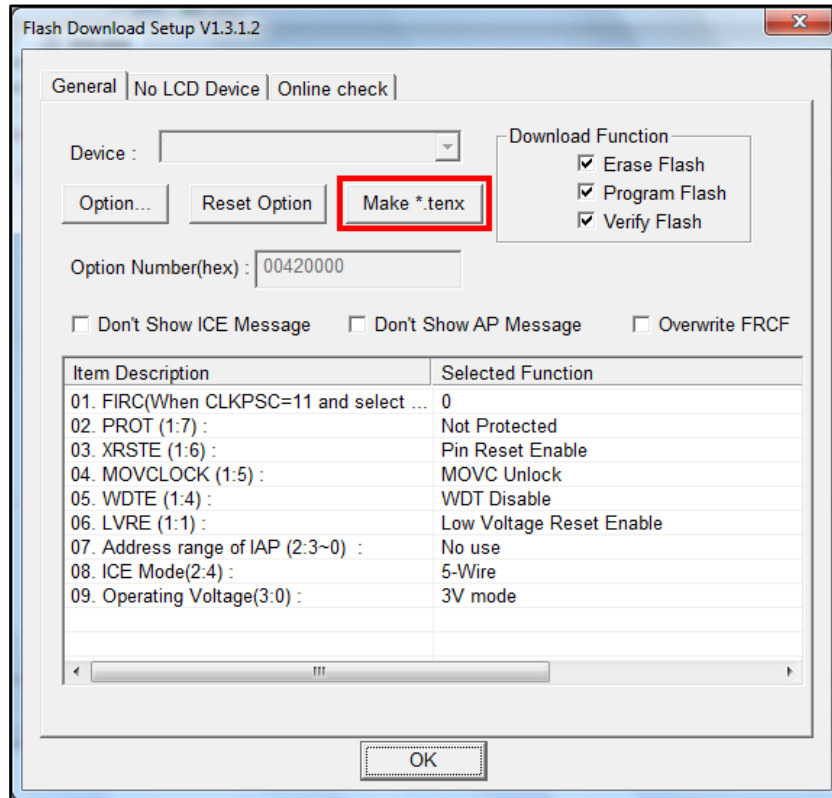

### Q2: How to use UV3 and UV4 version in the same time ?

A2: If user wants to install UV3 and UV4 version in the default path (UV3 & UV4 version in C: \Keil) in the same time, the user musts to change C51 folder name(because there will be two C51 folders), and then install tenx F51 & L51 IDE file, if user needs to use UV3 version, the UV4 version must to change C51 folder name. However, the user wants to install UV3 and UV4 version in the different path (UV3 version in C: \Keil, UV4 version in D: \Keil), the tenx F51 & L51 IDE & Keil C version (UV3 or UV4) must be installed in the same path.

**Q3: Why the user clicks on “Debug” button as shown below window ?**

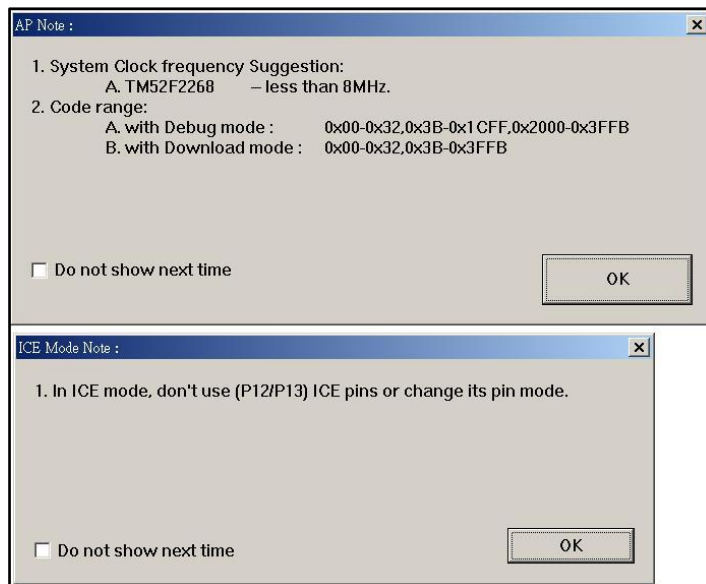

**A3:** When the user writes program file must be avoid to control P1.2、P1.3 pin (For example: P1 Mode configuration change), if do not show this window in the next time, please check “Do not show next time” option, or to confirm “Don’t Show ICE/AP Message ” is checked in the “Flash Download Setup” window.

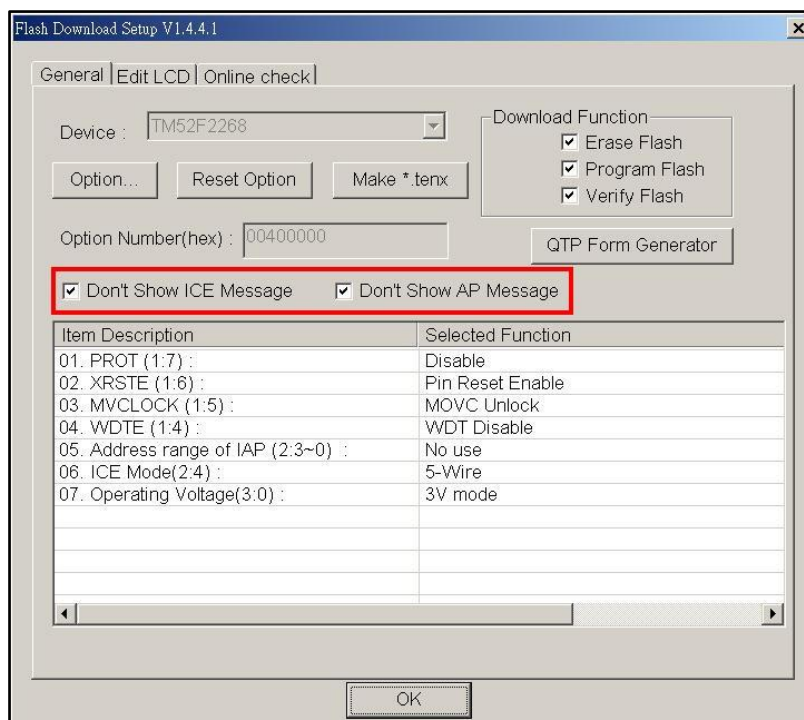

**Q4:** Why the user clicks on “Debug” button as shown below window, and then exit the “Debug Mode” ?

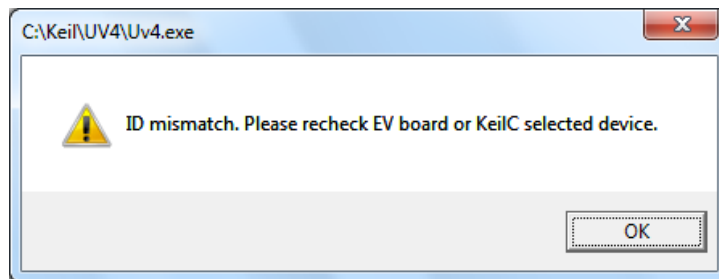

**A4:** Because the user selects chip model and EV Board model does not match, please recheck chip model and EV Board model.

**Q5:** Why the user clicks on “Debug” button or “Download” button as shown below window, and then exit the “Debug Mode” or “Download Mode” ?

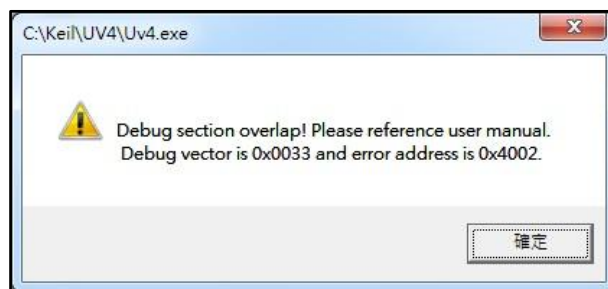

**A5:** Because the user writes program file is out of “ROM code” range, please refer Note (2) in Page 14.

**Q6: Why the user clicks on “Debug” button as shown below window, and then exit the “Debug Mode” ?**

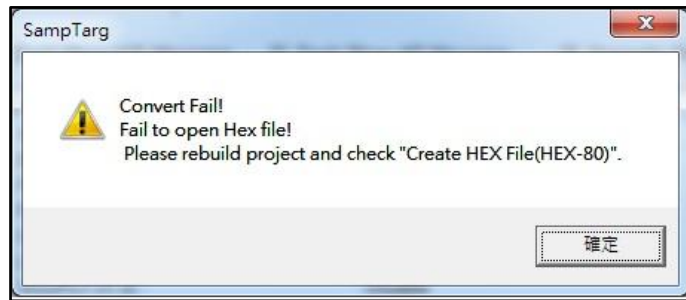

**A6:** Because the “Create HEX File” is not checked in “Output” option, please refer below figure.

